

2002-07 GENINFO

Multiple Restraint System - Overview - MINI

MINI MULTIPLE RESTRAINT SYSTEM 5

MULTIPLE RESTRAINT SYSTEM (MRS 5)

Purpose of the System

The multiple restraint system 5 (MRS 5) provides enhanced passive protection for vehicle occupants in the event of a serious collision. The system is regarded as passive in the respect that it operates automatically without interactions by the vehicle occupants.

It differs from the previous MRS4 system in that reaction time is decreased and accuracy increased due to the addition of the door pressure sensors and up front sensors.

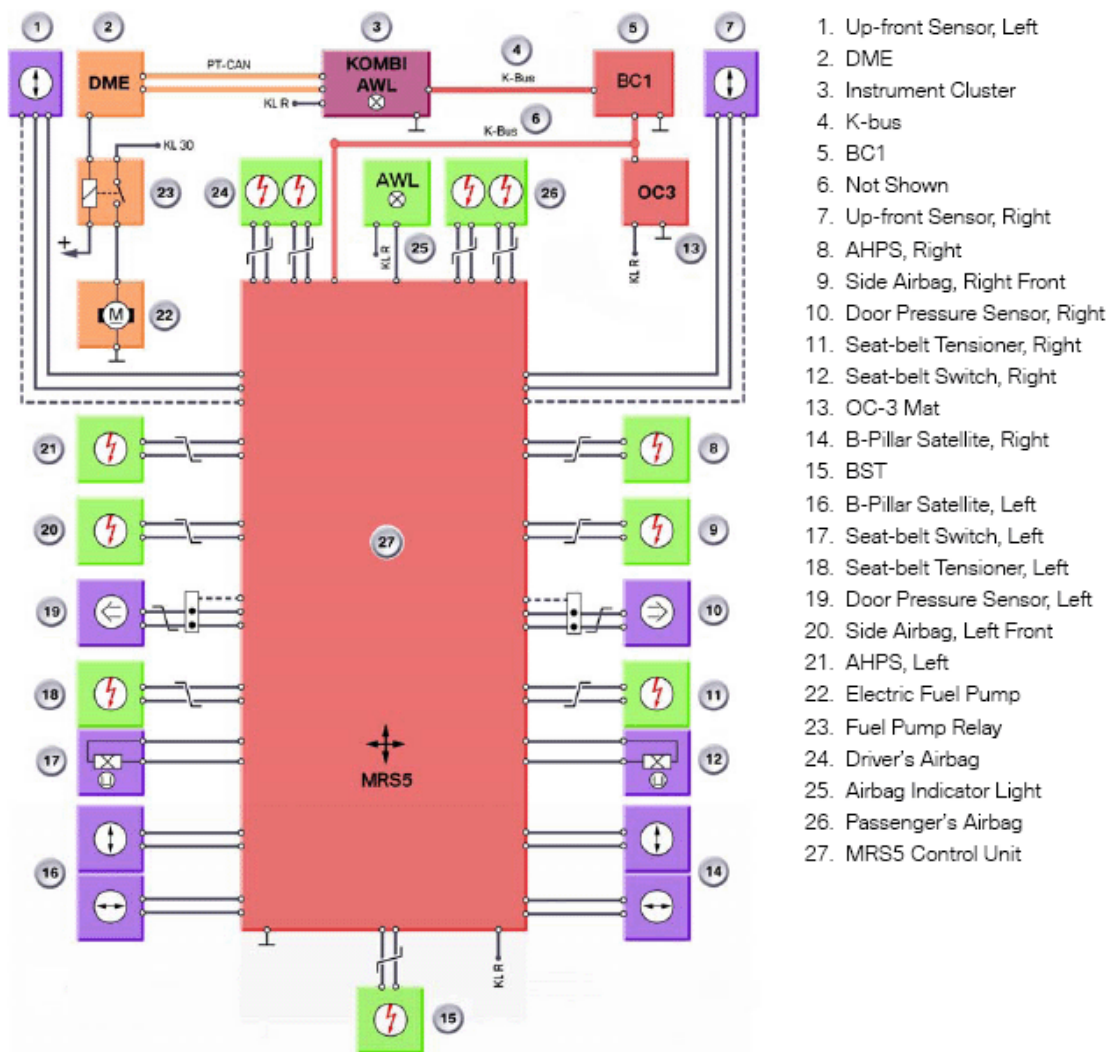

**Fig. 1: Multiple Restraint System 5 (MRS 5) Function**  
**Courtesy of BMW OF NORTH AMERICA, INC.**

**System Components**

The MRS5 system consists the following components:

- MRS5 control unit
- Crash sensors - "b" pillar (x 2)
- Crash sensors - up front (x 2)
- Door pressure sensors (x 2)
- MRS warning lamp (in IKE)
- Slip ring
- Passenger seat occupancy detector (OC-3)
- Seat belt switches
- Driver's airbag module
- Front passenger's airbag module
- Driver's side (thorax) airbag module
- Front passenger's side (thorax) airbag module
- Advanced head protection system (AHPS2) airbag - right hand
- Advanced head protection system (AHPS2) airbag - left hand
- Driver's seat belt pre-tensioner
- Front passenger's seat belt pre-tensioner
- Battery Safety Terminal

## 2006 MINI Cooper

2002-07 GENINFO Multiple Restraint System - Overview - MINI

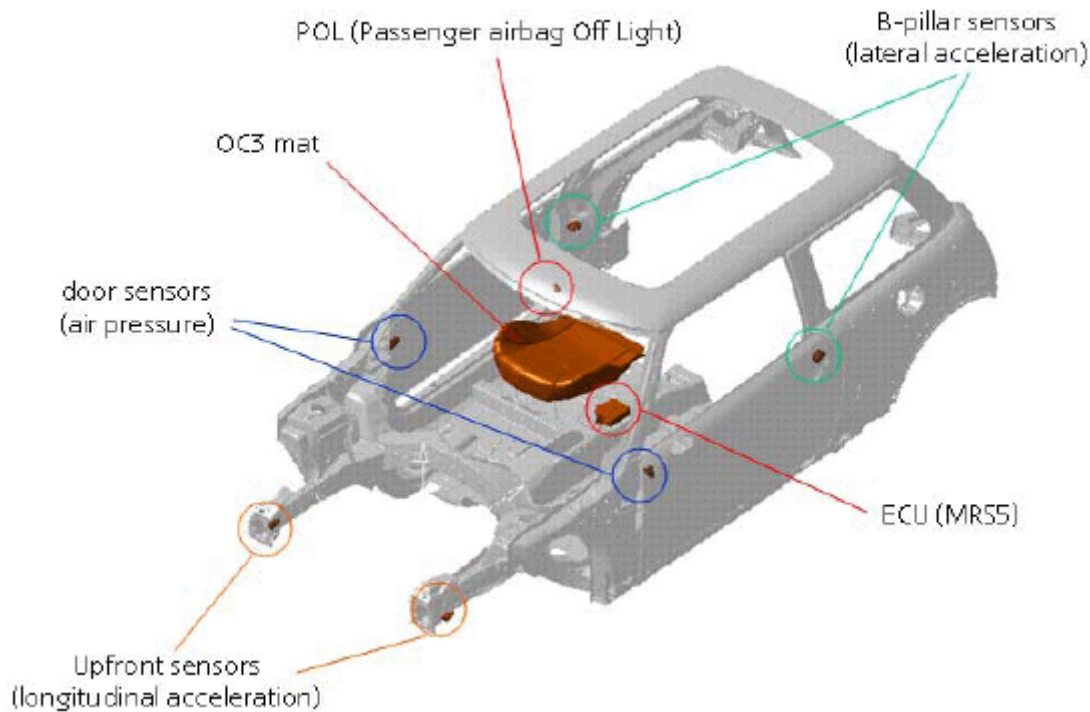

**Fig. 2: Multiple Restraint System 5 (MRS 5) Components**  
Courtesy of BMW OF NORTH AMERICA, INC.

### MRS 5 Control Unit

The MRS 5 control unit is secured centrally on the body floor panel (center tunnel - between the handbrake and the gear selector lever) by two nuts. Access to the control unit is only possible when the main floor carpet is removed from the vehicle.



**MRS Control Unit**

**Fig. 3: MRS Control Unit**  
Courtesy of BMW OF NORTH AMERICA, INC.

The MRS 5 performs internal diagnosis and monitors all inputs and outputs. Any faults that may occur are stored as non-volatile memory in the control unit and indicated to the driver by way of the airbag warning lamp (AWL).

Communication with other control units in the vehicle system network takes place via the K-bus. In the event of a crash, a K-bus protocol is transmitted via a separate data line to the telematics control unit (TCU) and the emergency call triggered.

The MRS 5 can be encoded via the K-CAN. Diagnosis of the MRS control unit takes place via the diagnosis bus in the gateway module of the junction box which then forwards the diagnosis commands on the K-CAN.

#### Connector

The module has been expanded from one to two connectors.

- One 26-pin connector is for the cockpit
- One 54-pin connector if for the vehicle harness.



**MRS Control Unit**

#### **Fig. 4: MRS Control Unit Connector**

**Courtesy of BMW OF NORTH AMERICA, INC.**

#### Crash Sensors

In addition to the two acceleration sensors in the MRS 5 control unit, satellites are installed in the B-pillars, frame rails, and doors.

Together with the acceleration sensors in the MRS 5 control unit, the longitudinal, transverse acceleration sensors and door pressure sensors serve the purpose of detecting side crashes.

The longitudinal acceleration sensors detect front end and rear end crashes.

#### B-Pillar Satellite



**Fig. 5: B-Pillar Satellite (1 Of 2)**

Courtesy of BMW OF NORTH AMERICA, INC.



**Fig. 6: B-Pillar Satellite (2 Of 2)**

Courtesy of BMW OF NORTH AMERICA, INC.

The B-pillar satellite consists of a longitudinal acceleration sensor and a transverse acceleration sensor. These B-pillar satellites serve the purpose of protecting frontal, side and rear end crashes. The left and right sensors are of identical design and are allocated by way of mechanical coding during installation. The sensors measure in both directions.

The acceleration values registered by the micromechanical acceleration sensors are converted to digital signals. With the aid of a data telegram, the digital signals are transmitted control unit.

The main sensor direction provides a positive signal so that the control unit recognizes the direction of impact.

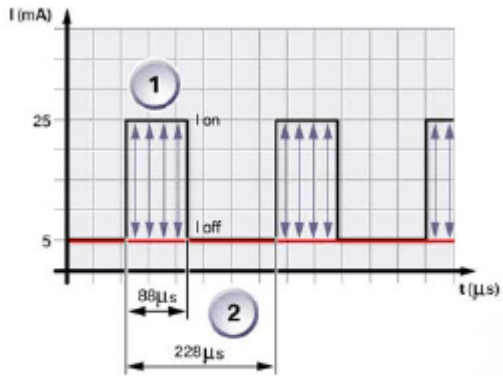

- 1. Data telegram with acceleration values
- 2. Data telegram spacing

**Fig. 7: Main Sensor Positive Signal**  
Courtesy of BMW OF NORTH AMERICA, INC.



1. Mechanical coding

**Fig. 8: Mechanical Coding**  
Courtesy of BMW OF NORTH AMERICA, INC.

Up Front Sensor



**Fig. 9: Up Front Sensor (1 Of 2)**

Courtesy of BMW OF NORTH AMERICA, INC.



**Fig. 10: Up Front Sensor (2 Of 2)**

Courtesy of BMW OF NORTH AMERICA, INC.

The job of the up-front sensors is to detect frontal impacts. The up-front sensors are located on the front frame rails. The up-front sensors provide the MRS control unit with the initial information on the progression and severity of the impact.

An up-front sensor consists of an acceleration sensor for detecting deceleration, a signal converter and a microprocessor for data transmission. The up-front sensors supply a digital data message consisting of 11 bits (2 start bits, 8 data bits and 1 check bit) that is transmitted cyclically every 228  $\mu$ s.

The up-front sensors are supplied with power via a current-signal interface. The up-front sensors are supplied with a current of 5 - 10 mA. When a data message is transmitted, the level jumps vertically by 20 mA.

The advantage of the current-signal interface is its constant supply of current which prevents corruption of the signal. A change of resistance in the lead does not affect the signal.

A power supply with a voltage signal would be corrupted by changes in resistance in the lead. The signal could equally be corrupted by EMF interference from other leads.



1. Data message length (11 bits)
2. Data message cycle

**Fig. 11: Data Message Cycle Graph****Courtesy of BMW OF NORTH AMERICA, INC.****Door Pressure Sensor****Fig. 12: Door Pressure Sensor (1 Of 2)****Courtesy of BMW OF NORTH AMERICA, INC.****Fig. 13: Door Pressure Sensor (2 Of 2)****Courtesy of BMW OF NORTH AMERICA, INC.**

The function of the door pressure sensors is to provide supplementary detection of side impacts in addition to the information supplied by the lateral acceleration sensors in the B-pillar satellites and the MRS5 control unit. The door-compression sensors are located on the inner door panel and measure the pressure inside the door.

In the event of a side impact, the outer door panel may be pushed inwards, thus compressing the space inside the door and increasing the pressure. That pressure increase is detected by the door pressure sensors.

A door compression sensor contains not only a pressure sensor but also an electronic module. The pressure readings are digitized and transmitted cyclically as a data message to the MRS5 control unit.

At the same time, the side impact is detected by the acceleration sensors in the B-pillar satellite. The B-pillar satellite then also transmits a data message. The MRS5 control unit in the center of the vehicle processes the two signals and is able to trigger the restraint systems on the basis of the information provided.





**Door Pressure Sensor Mounting**

**Fig. 14: Door Pressure Sensor Mounting**  
Courtesy of BMW OF NORTH AMERICA, INC.

**Airbag Warning Lamp (in IKE)**

The red MRS warning LED is located in the instrument cluster and is illuminated for a short period after switching the ignition to position 1.

If a fault is present within the MRS, the LED will illuminate and remain on until the ignition is switched off. With the warning LED illuminated, the MRS may not operate in the event of a collision.

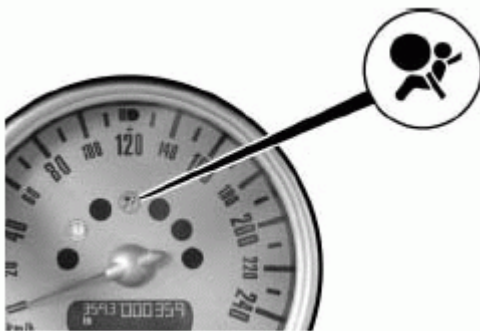

**Fig. 15: Airbag Warning Lamp**  
Courtesy of BMW OF NORTH AMERICA, INC.

**Slip Ring (Rotary Coupler)**

The slip ring is installed on the steering column, behind the steering wheel to provide the electrical interface between the fixed wiring harness and the moveable driver airbag module. The rotary coupler is attached to the steering column casting by three screws.

In addition to the wiring for the driver airbag, the slip ring also provides the wiring for other electrical functions built into the steering wheel area, these may include:

- Audio system remote control switches

- Cruise control system switches
- Horn switches

A rotating link harness is enclosed in a plastic cassette comprising outer and inner housings with integral connectors. The cassette contains a flat ribbon type flexible cable. The slip ring housing is part of the direction indicator and windshield wiper/washer housing. The complete assembly is attached to the steering column by three screws.

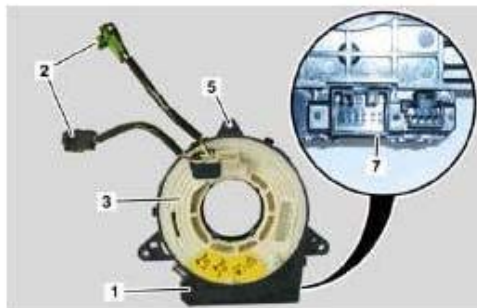

1. Outer Ring
2. Pigtail Connectors to Driver's Airbag Module X2
3. Rotary Unit
5. Mounting Holes X 3
7. MRS Harness Connector

**Slip Ring**

**Fig. 16: Slip Ring**

**Courtesy of BMW OF NORTH AMERICA, INC.**

#### **Seat Occupancy Detector (OC-3 Mat)**

The purpose of the OC-3 mat is to monitor the presence of a person or object placed on the front passenger's seat and determine whether the passenger airbags should be deactivated. The OC-3 mat is capable of detecting a child seat that conforms to the relevant standard (NHTSA FMVSS 208) by virtue of the pattern of the impression it makes on the seat and deactivates the passenger airbags.

The previous SBE mat recognized a certain weight as proof that the seat is occupied. In order to meet legislative requirements, the seat occupancy detector (SBE) has been developed into an intelligent occupant classifier (OC). This was achieved by means of the following measures:

- By a larger number of sensor elements
- By sensing a larger area of the seat
- By an intelligent electronic analyzer

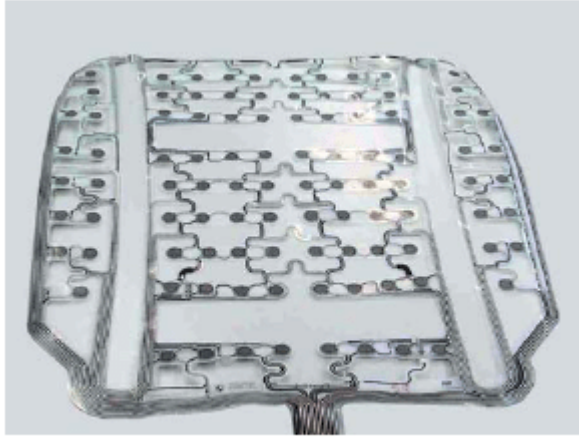

OC3 Mat

**Fig. 17: OC3 Mat**

Courtesy of BMW OF NORTH AMERICA, INC.



Convention Seat Occupancy Detector

**Fig. 18: Convention Seat Occupancy Detector**

Courtesy of BMW OF NORTH AMERICA, INC.

The OC-3 mat is capable of distinguishing between a one-year-old child in a child's seat and a light person.

The OC-3 mat is integrated into the seat area of the passenger seat. The OC-3 mat consists of conductors with pressure-dependent resistor elements (FSR, or Force Sensitive Resistance elements). The conductors are connected to the electronic analyzer.

The FSR elements are wired in such a way that they can be sampled individually. When the mechanical load on a sensor element increases electrical resistance decreases and the measurement current changes accordingly.

By analyzing the signals from the individual sensors, the analyzer maps the occupancy of the seat surface and can identify the local concentrations of weight. The distances between the areas where pressure is applied and the concentrations of pressure reveal whether the seat is occupied by a person (A) or a child seat (B) (diagram on next page)

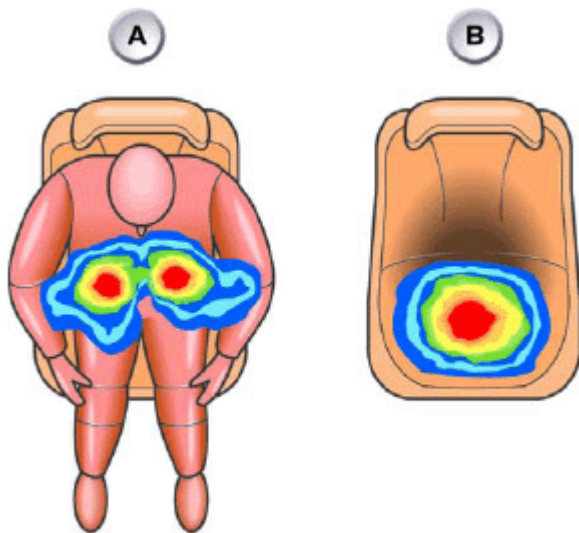

**Fig. 19: Seat Is Occupied By Person Or Child Seat**  
Courtesy of BMW OF NORTH AMERICA, INC.

The analyzer of the OC-3 mat sends a message to the MRS5 control unit via the K-bus. If the system detects that the seat is unoccupied or that a child seat for a child up to one year old is fitted, the airbags on the passenger side are deactivated. The MRS5 control unit switches on the airbag warning light. The airbag warning light indicates that the airbags on the passenger side are deactivated.

#### Airbag Warning Light (status LED)

The airbag indicator lamp is located in the roof vehicle center (coupe) or on the windshield frame next to the convertible top and rear window switches (convertible). The airbag indicator lamp is activated and lights yellow when the front passenger airbag and the side passenger airbag are deactivated.



**Fig. 20: Airbag Warning Light**  
Courtesy of BMW OF NORTH AMERICA, INC.

#### Belt Buckle Switch

The belt buckle switch is used to detect whether the seatbelt has been fastened or not. The detection signal is sent to the MRS5 control unit. The signal is used as a criterion for selective triggering of the actuators in the event of a crash. The belt buckle switches are located in the seatbelt buckles of both front seats.

The belt buckle switch is a two-wire Hall switch. The Hall switch is supplied by the MRS5 control unit via a current-signal interface. The current draw of the switch is the signal for the switch position. The belt buckle switch is permanently diagnosed and monitored in all electrical system statuses from Terminal R "ON" onwards.

#### Pyrotechnic Devices

##### Driver's Airbag Module

The driver's airbag is of a two-stage design and attached to the steering wheel by two captive bolts. Electrical connection to the MRS control unit is provided via the rotary coupler. Once the airbag is fully inflated, vents in the airbag prevent further pressure build-up, so that progressive deceleration is provided as the driver contacts the cushion and injury due to sudden impact forces is prevented.

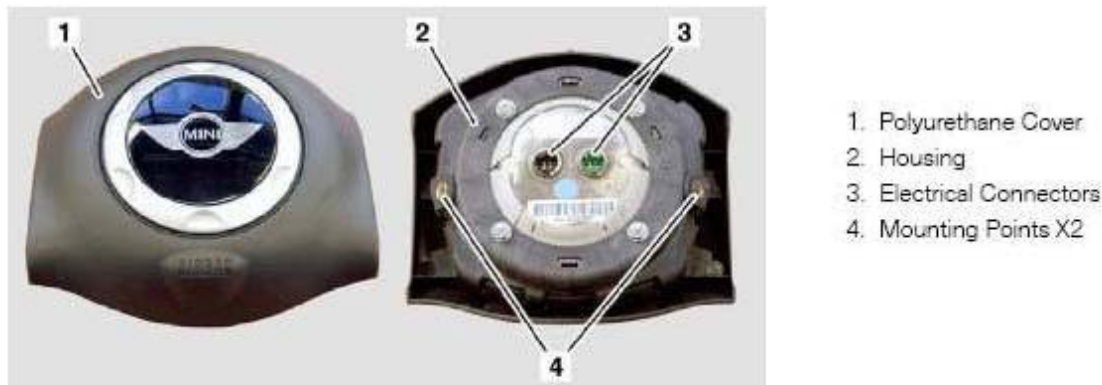

**Drivers Airbag Module**

#### **Fig. 21: Driver Airbag Module**

Courtesy of BMW OF NORTH AMERICA, INC.

##### Passenger Airbag Module

The passenger front airbag module is located above the glove box, directly in front of the passenger seat. The airbag module is mounted to the body cross car beam. The unit contains a gas generator and igniter module.

Upon deployment, airbag tears the dashboard cover through several predetermined sheer points (dashboard cover would have to be replaced). Once free of the housing and fascia the airbag inflates to its full extent to provide a protective cushion between the front seat passenger and the fascia/windshield. Vents in the airbag prevent excess pressure bursting the bag and, as soon as the material in the gas generator is exhausted, the airbag deflates.

## 2006 MINI Cooper

2002-07 GENINFO Multiple Restraint System - Overview - MINI



Passenger Airbag Module

**Fig. 22: Passenger Airbag Module**

Courtesy of BMW OF NORTH AMERICA, INC.

**NOTE:** Only use the service connector when removing the airbag. The connector at the airbag itself should not be tampered with.

### Side (Thorax) Airbag Modules



Side Airbag Module (coupe)

**Fig. 23: Side (Thorax) Airbag Modules (1 Of 2)**

Courtesy of BMW OF NORTH AMERICA, INC.



**Fig. 24: Side (Thorax) Airbag Modules (2 Of 2)**

## 2006 MINI Cooper

2002-07 GENINFO Multiple Restraint System - Overview - MINI

### Courtesy of BMW OF NORTH AMERICA, INC.

The driver and passenger side (thorax) airbags are mounted to the front seat backrest frame and are designed to protect the front driver and front passenger during a side impact.

There are two variants of side airbag modules available:

- Smaller version for coupes
- Larger version for the convertible.

The reason for the two variants is that a coupe is equipped with AHPS while the convertible does not. The side airbag module on the convertible is larger in size and is designed as a head protection airbag as well.

The modules are side specific (i.e. a right hand module must be fitted to a right hand seat and a left hand module must be fitted to a left hand seat). The side airbags are activated by a control signal from the MRS control unit in the event of a side impact or a front angled impact of sufficient severity to cause both front and side airbag deployment.

The side (thorax) airbag module consists of a molded plastic case which houses a folded nylon fabric bag, the gas generating capsules and an igniter squib. The rear of the side airbag module features two studs that are used for mounting the module to the seat frame and are secured in position by two nylon lock nuts.

The side airbag modules have a 2-pin connector under the seat where it connects to the main harness.

### Workshop Hint

If a new side airbag module shows any sign of damage, **DO NOT USE**.

### Workshop Hint

Do not try to remove the connector at the module end, it is a permanent connection.

### Advanced Head Protection System (AHPS)

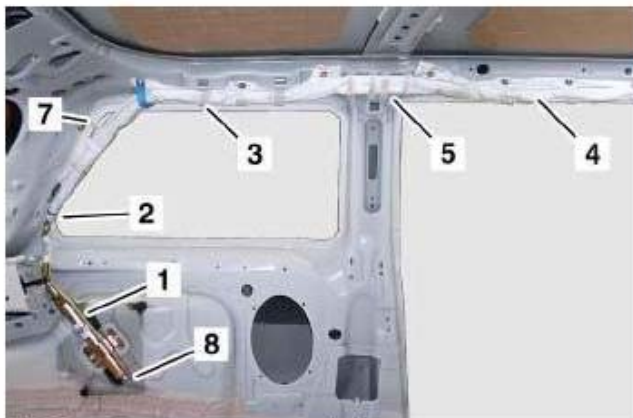

1. Igniter/Gas Generator
2. Crimped Metal Clip
3. Plastic Retaining Clips X 6
4. Inflatable Nylon Bag
5. Bracket (At Top of B Pillar)
6. Front Tether Strap (Secured on A Pillar) not shown
7. Rear Tether Strap (Secured on C Pillar)
8. Electrical Connector

AHPS

**Fig. 25: Advanced Head Protection System (AHPS)**  
Courtesy of BMW OF NORTH AMERICA, INC.

The head airbag, known as the Advanced Head Protection System (AHPS2) offers the vehicle occupants in the front and rear additional protection from impacts. The airbag is located behind the interior trim above the door and rear side glass. The igniter/gas generators are fixed to the body rear inner side panels in the luggage compartment. The airbag itself is tethered to the body by two securing straps and bolts, one at the A post, the other on the C post.

In between the two tether points, the airbag is held in place with six plastic clips, which are designed to break apart as the airbag inflates. The center portion of the folded airbag is retained on a metal bracket which itself is secured to the body by two bolts and located at the top of the B post.

The 15 liter head airbag is filled with nitrogen/argon gas from a pressurized chamber and remains inflated slightly longer than conventional airbags, this is to provide additional head protection in the event of a secondary impact.

To disconnect the vehicle harness lead from the gas generator, lift the locking cap of the connector to unlatch and then pull the connector away from the module. Do not pull on the harness lead. When reconnecting, ensure the connector is fully mated in the socket of the airbag module then press the hinged locking cap into place to secure the connector in position.

#### **Seat Belt Pre-Tensioners**

Inertia reel three point seat belts are installed on the front seats. The inertia reels are of the ALR (Automatic Locking Retractor) type. The MRS control unit at a slightly lower threshold level than the front airbags activates the front seat belt pre-tensioners.

The two pre-tensioners are side specific, but otherwise identical. Each pre-tensioner has a tube containing propellant and a piston. The piston is attached to a steel cable, the opposite end of which is attached to the seat belt buckle. An igniter (squib) in the base of the tube provides an ignition source when triggered by a fire signal from the MRS control unit. A fly lead with a 2-pin connector links the igniter to the vehicle's MRS wiring and is located on a bracket underneath the seat frame.



**Fig. 26: Seat Belt Pre-Tensioners**



**Courtesy of BMW OF NORTH AMERICA, INC.****Battery Safety Terminal (BST - COOPERS Only)**

The BST is installed in the COOPER S due the battery location in the luggage compartment. The BST is used to minimize the possibility of a short circuit to the heavy gauge B+ wire that runs the length of the vehicle in the event of an accident.

The BST consists of a conventional clamp that is screwed onto the positive terminal from above and connected with a hollow cylinder. A propellant charge is stored in this hollow cylinder. Just as with the airbag and seat belt pre-tensioner, this pyrotechnic device is controlled and ignited by the MRS5 control module. The triggering strategy is also the same as for the triggering of the airbag, and it possesses identical protection logic. The overall unit is enclosed in a plastic shell that captures the cable if it is forced out and locks it so that a renewed contact is no longer possible.



1. 2-pin Connector from MRS5 Control Unit
2. Propellant Charge

**Fig. 27: Seat Belt Pre-Tensioner**

**Courtesy of BMW OF NORTH AMERICA, INC.**

**Principles of Operation****MRS 5 Control Unit**

The MRS5 control unit performs the following functions:

- Crash detection and determining triggering point
- Triggering the ignition output stages
- Documentation of crash data
- System self-test
- Cyclic monitoring
- Display of system standby status
- Fault indication and fault code storage
- Fault output (diagnosis)
- Output of a crash telegram for other users in the communication system network

- Activation of the airbag indicator lamp when the passenger airbag is deactivated

#### **Crash Detection and Determining Triggering (ignition) Point**

The MRS 5 control unit determines whether a crash situation has occurred based on the values detected by the sensors and the triggering algorithm. The threshold values of two independent sensors must be detected in order to detect a crash. In the case of a frontal crash for example, the acceleration values from the B-pillar satellite and from the longitudinal acceleration sensor must be detected in the control unit.

The values serve the purpose of determining the crash severity and the crash direction. Based on the crash severity and direction, an algorithm determines the triggering (ignition) points of the restraint systems to be activated.

#### **Triggering the Output Stages of the Ignition Circuits**

The values from two different sensors, from the B-pillar satellite and MRS control unit sensor must be applied in order to trigger the output stages of the ignition circuits.

Voltage is supplied to the MRS 5 control unit as from terminal R "ON" and the unit is operational once it completes a system self test.

The ignition capacitor that serves as an energy reserve is charged by means of a chopper-type regulator. The ignition capacitor provides the energy reserve in the event of a crash with the power supply interrupted.

The output stages of the ignition circuit consists of a high side and a low side power switch. The high side power switch switches the triggering (ignition) voltage, the low side power switch switches ground (earth). The output stages of the ignition circuits are controlled by the microprocessor.

The high side and low side power switches also serve the purpose of checking the ignition circuits during the system self-test.

#### **Documentation of Actuator Triggering in Terms of Time**

The triggering (ignition) commands must be recorded in the event of a crash where one or several actuators are triggered. The most important data of a crash event are stored in the form of a crash telegram in the non-volatile memory of the control unit. Only the development departments can read the crash telegrams.

A maximum of 3 crash telegrams can be stored. The control unit must then be replaced.

#### **System Self-test**

The MRS 5 performs a system self-test as from terminal R "ON". The airbag warning lamp is actuated for 3 - 5 s during the system self-test.

When the system self-test is concluded and no fault has been found, the airbag warning lamp goes out and the system is ready for operation.

#### **Cyclic Monitoring**

## 2006 MINI Cooper

2002-07 GENINFO Multiple Restraint System - Overview - MINI

Once the system self-test has been successfully concluded and the system is ready for operation, a cyclic monitoring procedure is performed for fault monitoring purposes. Cyclic monitoring is carried out for as long as the system is at terminal R "ON".

### Indication of System Operability

The system operability of the MRS 5 is indicated by the airbag warning lamp AWL going out in the instrument cluster.

### Fault Indication and Fault Code Storage

A fault in the system is indicated by the airbag warning lamp.

If a fault occurs in the MRS 5 system, the corresponding fault code is stored in a nonvolatile fault code memory. A distinction is made between internal and external faults when entering the fault code.

### Fault Output (diagnosis)

With the aid of the diagnostic tools (DIS plus, GT1), the fault code memory can be read out via the diagnosis interface.

After rectifying the faults, the fault code memory can be cleared by means of the "clear fault code memory" diagnosis command.

### Output of Crash Telegram

In the event of a crash involving triggering of the restraint systems, the MRS 5 control unit sends a crash telegram to the users in the bus system network.

As a result, the respective control units perform the following functions corresponding to the crash severity:

### CONTROL UNIT FUNCTION

Control Unit	Function
DME	Switch off fuel pump
BC1	Release central locking
BC1	Activate hazard lights
BC1	Activate interior lights
BC1	Open windows

### Deactivation of Passenger Airbags

The front and side passenger airbags must be deactivated when a child seat is mounted on the passenger's side. This MRS utilizes an OC-3 mat for passenger seat occupancy recognition.

Airbag deactivation is indicated by the yellow symbol lighting in the airbag indicator lamp. Deactivation and activation of the passenger airbag is the responsibility of the vehicle driver.

**Seat Belt Reminder Function**

A seat belt reminder function is installed on this MRS version for the driver and passenger. The Seat Belt Reminder SBR function monitors whether the driver or passenger has fastened his/her seat belt. If not, a corresponding indicator reminds them to fasten their seat belt. Both seat belt buckle switches are monitored separately.

If the seat belt is not worn or the seat belt is unbuckled while driving at a speed in excess of approx. 1 km/h, there will be an audible and visual warning given.

The seat belt warning is given by:

- Fixed seat belt indicator lamp (seat belt symbol)
- Audible warning provided by the gong

The SBR function is subdivided into two phases. The first phase is the initialization, i.e. fastening the seat belt before driving off and during the first 200 m covered. The second phase involves monitoring while driving, i.e. the system monitors whether the occupants have their seat belts fastened during vehicle operation.

**Phase 1 Initialization**

Phase 1 begins with terminal 15 ON and remains active until the respective seat belt contact is closed or terminal 15 OFF is detected.

At terminal 15 ON, the fixed indicator lamp for seat belt warning in the instrument cluster is activated until the seat belt is fastened. The seat belt warning lamp requests the driver to buckle his/her seat belt.

No warning is given over the first 200 m if the seat belt buckle is detected as open (unbuckled). This provides the driver with the opportunity to drive out of the garage for example and to close the door or to reposition the vehicle without the audible or visual warning signal triggering.

An audible and visual warning signal is given after a distance of 200 m has been exceeded and the system detects that the driver's seat belt buckle has not been fastened or the front passenger's seat belt buckle has not been fastened and the seat is detected as occupied.

The gong is additionally activated intermittently for maximum 90 sec or until the seat belt is fastened. At the same time, the variable indicator lamp with the seat belt warning symbol is activated. On vehicles with the central information display, a text message "Fasten seat belt" is displayed for maximum 23 sec.

**Phase 2 Monitoring During Vehicle Operation**

For the driver, the transition to phase 2 takes place when the seat belt buckle switch detects a fastened seat belt after approx. 15 sec or when covering the specified distance(>200 m). If the front passenger seat is detected as occupied, the front passenger switch must also detect that the passenger seat belt is fastened so as not to trigger a warning.

A visual and audible warning is triggered 15 sec after unbuckling the seat belt while driving. The gong is

## 2006 MINI Cooper

2002-07 GENINFO Multiple Restraint System - Overview - MINI

activated intermittently for maximum 90 sec or until the seat belt is fastened again. At the same time, the seat belt warning symbol is activated.

If a warning was given for more than 90 sec, the SBR function is not activated again until the seat belt has been fastened and unbuckled again.